



Wasch- und Nachspülsysteme

Seite 204



Diverses und Luftfallen

Seite 205



Ablauf- und Filtersysteme

Seite 206



Tür- und Haubenmechanik

Seite 206



Elektrokomponenten

Seite 207

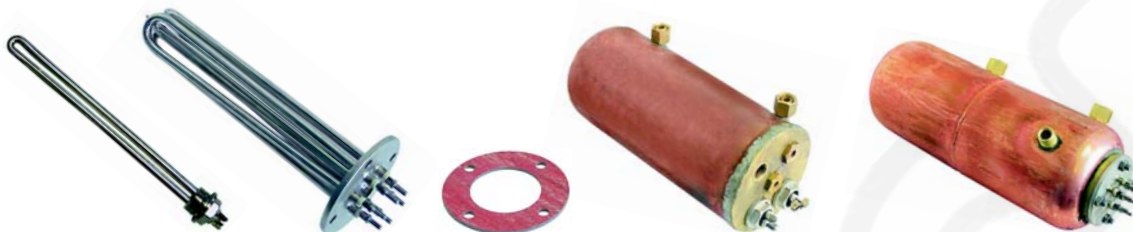

Heizkörper und Boiler

Seite 208



Pumpen und Ersatzteile

Seite 208

1 Wasch- und Nachspülsystem

Passend für Fabar



Abb.	Best.-Nr.	Beschreibung	Geräte-Typ	Vergl.-Nr.
1	503047	Waschrohr unten	T34I/ T34S	05063
2	503048	Waschrohr oben	T39I/ T39S	05063B
3	503049	Waschrohr seitlich		05064
4	503046	Waschdüse	T34I/ T34S, T39I/ T39S	05061
5	503060	Überwurfmutter 1"		06091
6	503061	Dichtung		06092



Abb.	Best.-Nr.	Beschreibung	Geräte-Typ	Vergl.-Nr.
1	503080	Nachspülrohr	T34I/ T34S	09127
2	503081	Nachspülrohr	T39I/ T39S	09127B
3	503082	Nachspüldüse	T34I/ T34S, T39I/ T39S	09128



Abb.	Best.-Nr.	Beschreibung	Geräte-Typ	Vergl.-Nr.
1	503056	Wasch- und Nachspülarm	Q35S	06087CI
2	503055	Wasch- und Nachspülarm	Q40S	06087I
3	503050	Nachspülarm/ oben	Q35S/ Q40S	06083

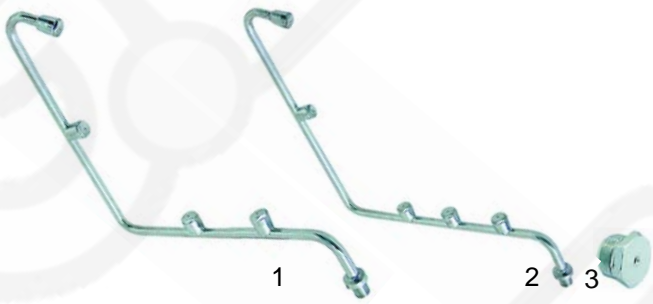

Abb.	Best.-Nr.	Beschreibung	Geräte-Typ	Vergl.-Nr.
1	503069	Wasch- und Nachspülarm		07098BI
2	503075	Wascharm/ unten	Q45F/ Q45FM	07103B
3	503072	Nachspülarm		07101B



Abb.	Best.-Nr.	Beschreibung	Geräte-Typ	Vergl.-Nr.
1	503068	Wasch- und Nachspülarm	Q50F/ Q50FA,	07098I
2	503074	Wascharm/ unten	Q50FM,	07103
3	503071	Nachspülarm	Q50FAM	07101

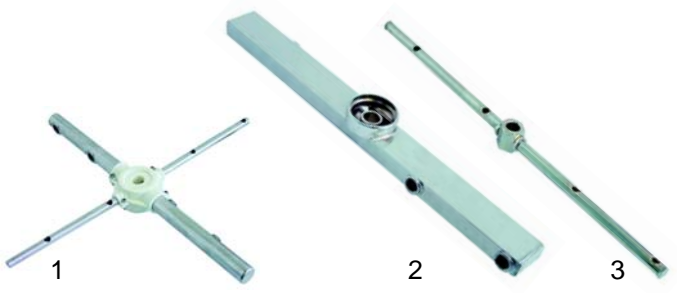

Abb.	Best.-Nr.	Beschreibung	Geräte-Typ	Vergl.-Nr.
1	503057	Nachspüldüse	Q35S, Q40S,	06088B
2	503111	O-Ring/ Nachspüldüse	Q45F, Q45FM,	15215
3	503073	Waschdüse	Q50F, Q50FA, Q50FM, Q50FAM	07102

Drehkorbsystem

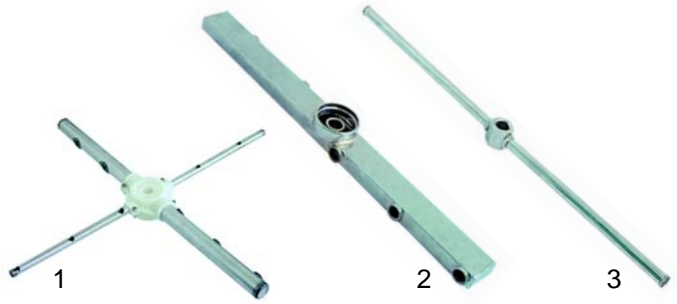

Abb.	Best.-Nr.	Beschreibung	Geräte-Typ	Vergl.-Nr.
1	503033	Drehteller		04039
2	503034	Drehtellerlager, kpl.		04040
3	503038	Mutter		04043
4	503039	Flügelschraube	T34I, T34S,	04044
5	503040	Lagermutter	T39I,	04045
6	503041	O-Ring	T39S	04046
7	503042	Mutter, 3/8"		04047
8	503044	Zugstange		04048
9	503045	Mutter, 1/4"		04049



Abb.	Best.-Nr.	Beschreibung	Geräte-Typ	Vergl.-Nr.
1	503041	Dichtung, 3/8"		04046
2	503042	Mutter, 3/8"	T34I, T34S,	04047
3	503084	T-Stück	T39T,	09129B
4	503086	Dichtung, 1/4"	T39S	09130
5	520702	Schraubkappe, 1/4"		09131

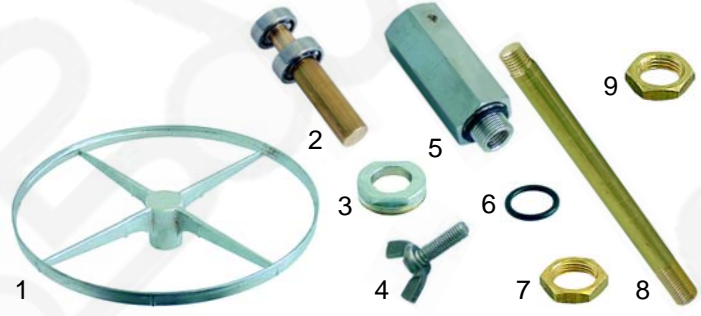

Abb.	Best.-Nr.	Beschreibung	Geräte-Typ	Vergl.-Nr.
1	503120	Nachspülarmhalter, oben		CUF3812
2	503042	Mutter, 3/8"		04047
3	503041	O-Ring	Q35S,	04046
4	503053	Nippel, 3/8", A/ M10I	Q40S	06085R
5	503051	Lagerbuchse		06084
6	503052	Nachspülstift		06085



Abb.	Best.-Nr.	Beschreibung	Geräte-Typ	Vergl.-Nr.
1	503059	Wascharmhalter		06090
2	503054	Schraube	Q35S, Q40S	06086
3	503062	Lagerbuchse		06104
4	503058	Wascharmstift		06089



Abb.	Best.-Nr.	Beschreibung	Geräte-Typ	Ver.-Nr.
1	503077	Wascharmhalter, unten	Q45F/ Q45FM	07105B
2	503076	Wascharmhalter, unten	Q50F/ Q50FA, Q50FM, Q50FAM	07105A
3	503112	Dichtung	Q45F/ Q45FM,	16241
4	503067	Flansch	Q50F/ Q50FA,	07096C
5	503070	Wascharmstift	Q50FM, Q50FAM	07099
6	503062	Lagerbuchse		06104
7	503052	Augenschraube		06085



Abb.	Best.-Nr.	Beschreibung	Geräte-Typ	Vergl.-Nr.
1	503066	Wascharmhalter, oben		07096C
2	503112	Dichtung	Q45F, Q45FM,	16241
3	503067	Flansch	Q50F, Q50FA,	07096C
4	503058	Wascharmstift	Q50FM,	06089
5	503062	Lagerbuchse	Q50FAM	06104
6	503054	Schraube		06086

Luftfalle

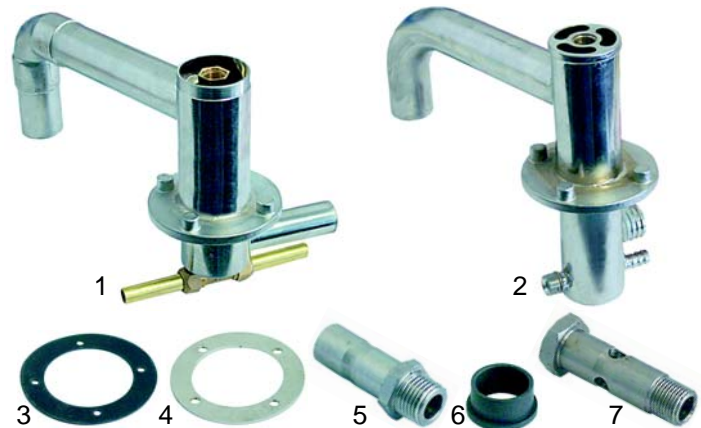

Abb.	Best.-Nr.	Beschreibung	Geräte-Typ	Vergl.-Nr.
1	503113	Luftfalle		21002
2	503119	Dichtung		21005
3	503115	Mutter	T34I/ T34S,	21003A
4	503118	Dichtung	T39I/ T39S,	21004
5	503117	Schlauchanschluss	Q35S/ Q40S,	21002C
6	503116	Überwurfmutter	Q45F/ Q50F,	21003B
7	503114	Schlauch, 4 x 1,5	Q50FA	21002A

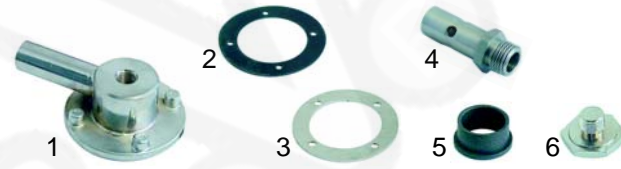

Abb.	Best.-Nr.	Beschreibung	Geräte-Typ	Vergl.-Nr.
1	503060	Überwurfmutter		06091
2	503061	Dichtung, konisch		06092
3	503020	O-Ring-Pumpe (Druck)		03030
4	503041	Dichtung, 3/8"	Q35S,	04046
5	503042	Mutter, 3/8"	Q40S	04047
6	503085	T-Stück		09129Q
7	503091	T-Stück, gebogen		09149I
8	503086	Dichtung, 1/4"		09130
9	520702	Schraubkappe, 1/4"		09131



Abb.	Best.-Nr.	Beschreibung	Geräte-Typ	Vergl.-Nr.
1	503078	Überwurfmutter 1"		07106
2	503138	Dichtung, konisch		07107
3	503109	O-Ring, Pumpe, Druck	Q45F/ Q45FM,	11165
4	503083	T-Stück	Q50F/ Q50FA,	09129
5	503086	Dichtung, 1/4"	Q50FM,	09130
6	520702	Schraubkappe, 1/4"	Q50FAM	09131

1 Ablauf- und Filtersysteme

Überlaufsystem



Abb.	Best.-Nr.	Beschreibung	Geräte-Typ	Vergl.-Nr.
1	503017	Überlaufrohr	T34I/ T34S	03028/A/F
2	503023	Ablauf, 1", kpl.	T39I/ T39S, Q35S/ Q40S	030310
3	503016	Überlaufrohr	Q45F/ Q45FM	03028B
4	503026	Ablauf, 1 1/4", kpl.	Q50F/ Q50FA, Q50FM/ Q50FAM	030320

Pumpen-Filter (Ansaugsystem)



Abb.	Best.-Nr.	Beschreib.	Geräte-Typ	Vergl.-Nr.
1	503108	Schraube + Filter	T34I/ T34S, T39I/ T39S	11164
2	503109	O-Ring, 1 1/4"	Q35S/ Q40S,	11165
3	503030	Filter	T34I/ T34S, T39I/ T39S	03035
4	503031	Filter	Q35S/ Q40S	030352

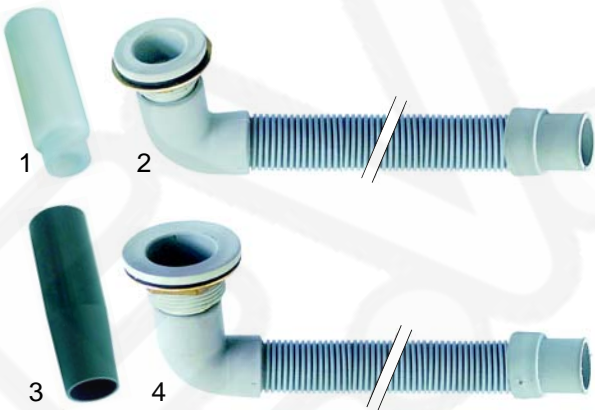

Abb.	Best.-Nr.	Beschreibung	Geräte-Typ	Vergl.-Nr.
1	503110	Mutter mit Filter	Q45F/ Q45FM,	12175
2	503079	O-Ring, 1 1/2"	Q50F/ Q50FA, Q50FM/ Q50FAM	08123
3	503032	Filter		03035A

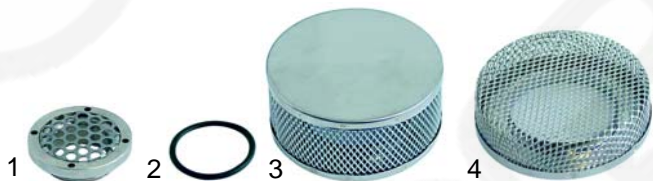

Abb.	Best.-Nr.	Beschreibung	Geräte-Typ	Vergl.-Nr.
1	503063	Steigrohr	Q45F/ Q45FM	07095B
2	503064	Steigrohr	Q50F/ Q50FM	07095C
3	503065	Steigrohr	Q50FA/ Q50FAM	07095D



Abb.	Best.-Nr.	Beschreibung	Geräte-Typ	Vergl.-Nr.
1	503107	Winkelstück	T34I/ T34S, Q35	10165B
2	503090	Verbindung (Boiler/ Magnetventil)	T34I/ T34S, Q35S	09149
2	503092	Verbindung (Boiler/ Magnetventil)	T39I/ T39S, Q40S	09149L
2	503137	Verbindung (Boiler/ Magnetventil)	T45F/ T45FM, T50F/ T50FM, T50FA/ T50FAM	09149E

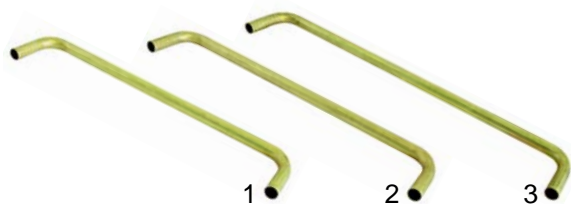

Abb.	Best.-Nr.	Beschreibung	Geräte-Typ	Vergl.-Nr.
1	503098	Heizrohr	T34I/ T34S,	10156
2	503041	O-Ring, 3/8"	T39I/ T39S,	04046
3	503042	Mutter, 3/8"	Q35S/ Q40S	04047
4	503099	Heizrohr	Q45F/ Q45FM,	10156E
5	503010	O-Ring, 1/2"	Q50F/ Q50FM,	02018
6	503043	Mutter, 1/2"	Q50FA/ Q50FAM	04047B

Tür- und Haubenmechanik



Abb.	Best.-Nr.	Beschreibung	Geräte-Typ	Vergl.-Nr.
1	503009	Türgriff		02017B
2	503010	Dichtung	T34I/ T34S, T39I/ T39S,	02018
3	503012	Mutter, 1/2"	Q35S/ Q40S,	02019
4	503013	Befestigungswinkel	Q45F/ Q45FM,	02020
5	503121	Zahnscheibe	Q50F/ Q50FM,	R0008A
6	503122	Schraube, M8 x 10	Q50FA/ Q50FAM	V810E
7	503093	Wasserhahn kpl.		101010

Elektrokomponenten



Abb.	Best.-Nr.	Beschreibung	Geräte-Typ	Vergl.-Nr.
1	503001	Mikroschalter-kit	ALLE	01035K
2	345363	Mikroschalter		01035
3	503104	Tauchhülse	T34I/ T34S, Q35	10158



Abb.	Best.-Nr.	Beschreibung	Geräte-Typ	Vergl.-Nr.
1	370239	Magnetventil	T34I/ T34S,	09132
2	503088	Nippel, 1/2" - 3/4"	T39I/ T39S,	09133
3	503089	Dichtung, 3/4"	Q35S/ Q40S,	09133B
4	371071	Magnetspule, 230V	Q45F/ Q45FM, Q50F/ Q50FM, Q50FA/ Q50FAM	09139

Schalter



Abb.	Best.-Nr.	Beschreibung	Geräte-Typ	Vergl.-Nr.
1	345558	Taster 3-fach	T34I/ T34S	13403
2	345557	Taster 1-fach	T39I/ T39S Q35S/ Q40S/ Q45F/ Q50F/ Q50FA	13401
3	345559	Schalter 2-pol.	Q45FM/ Q50FM/	13186
4	110340	Knebel	Q50FAM	13188

Timer



Abb.	Best.-Nr.	Beschreibung	Geräte-Typ	Vergl.-Nr.
1	360212	Timer 120°	T34S / T39S Q35S/ Q40S	13190F
2	360213	Timer 180°	Q45F/ Q50F/ Q50FA	13190M

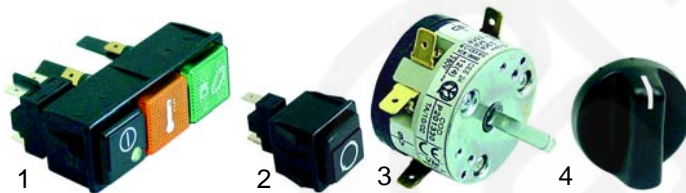

Abb.	Best.-Nr.	Beschreibung	Geräte-Typ	Vergl.-Nr.
1	360210	Timer 4° Wasserfüllung	Q45FM	130191
2	360211	Timer 120°	Q50FM	130190
3	110340	Knebel	Q50FAM	13188

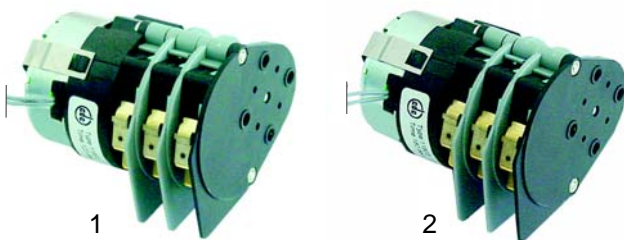

Abb.	Best.-Nr.	Beschreibung	Geräte-Typ	Vergl.-Nr.
1	541162	Pressostat 80/50	T34I/ T34S/ T39I/	21001A
2	365045	Entstörfilter	T39S/ Q35S/ Q40S/ Q45F/ Q50F/ Q50FA	13300

Thermostate

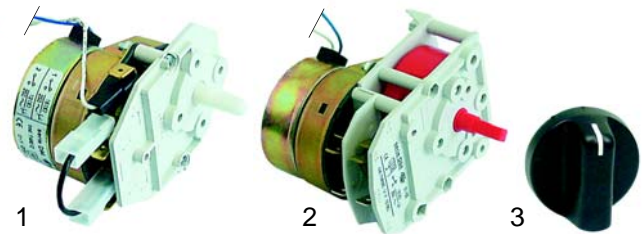

Abb.	Best.-Nr.	Beschreibung	Geräte-Typ	Vgl.-Nr.
1	390421	Thermostat 0-90°	T34I/ T34S/ T39I/ T39S/ Q35S/ Q40S/ Q45F/ Q50F/	14197
2	390023	Sicherheitsthermostat 110°C	Q50FA/ Q45FM/ Q50FM/ Q50FAM	141197A

Relais/ Schütze

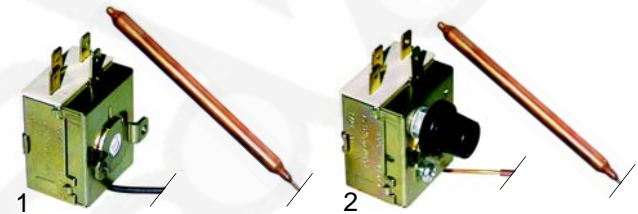

Abb.	Best.-Nr.	Beschreib.	Geräte-Typ	Vergl.-Nr.
1	380139	Relais	T39S/ Q40S/ Q45F/ Q50F/ Q50FA	13192C
2	380203	Schütz	Q45F/ Q45FM/ Q50F/ Q50FM/ Q50FA/ Q50FAM	13192

Signallampen

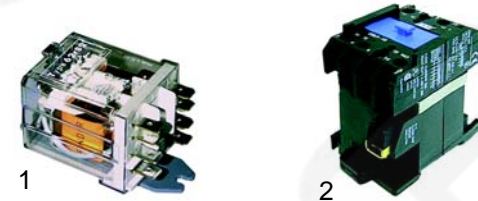

Abb.	Best.-Nr.	Beschreibung	Geräte-Typ	Vergl.-Nr.
1	359027	Signallampe grün	Q45 FM/ Q50FM/	13183B
2	359048	Signallampe gelb	Q50FAM	13183

Klemmleisten



Abb.	Best.-Nr.	Beschreibung	Geräte-Typ	Vergl.-Nr.
1	550488	Klemmleiste 3-pol.	T34 I/ T34S/ T39 I/ T39S/ Q35S/ Q40S/ Q45FM/ Q50FM/ Q50FAM	01213
2	550489	Klemmleiste 5-pol.	Q45F/ Q50F/ Q50FAM	01214
3	550034	Klemmleiste 5-pol.	alle	01212

Heizkörper und Boiler

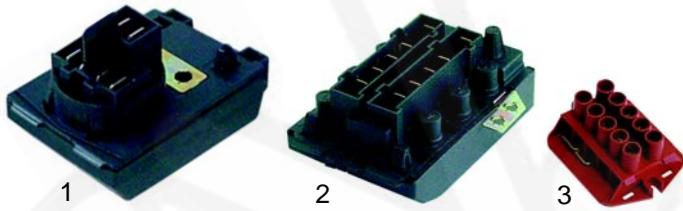

Abb.	Best.-Nr.	Beschreibung	Geräte-Typ	Vergl.-Nr.
1	415160	Heizkörper, 1000W/230V	T34I/ T34S/ Q35S	10163
2	415161	Heizkörper, 2700W	T39I/ T39S/ Q40S/ Q45F/ Q45FM	10162
3	415162	Heizkörper, 5000W	Q50F/ Q50FM/ Q50FA/ Q50FAM	10162B

Pumpen und Ersatzteile



Abb.	Best.-Nr.	Beschreibung	Geräte-Typ	Vergl.-Nr.
1	500334	Pumpe 0,55PS	T34I/T34S/ T39I/ T39S/ Q35S/ Q40S	111130
2	500336	Pumpe 0,75PS	Q45F/ Q45FM	121220
3	500335	Pumpe 1,0 PS	Q50F/ Q50FM/ Q50FA/ Q50FAM	121230



Abb.	Best.-Nr.	Beschreibung	Geräte-Typ	Vergl.-Nr.
1	503106	Dichtung Heizk.	T34I/ T34S/ Q35S	10161
2	503105	Dichtung Heizk.	T39I/ T39S/ Q40S/ Q45F/ Q45FM/ Q50F/ Q50FM/ Q50FA/ Q50FAM	10160

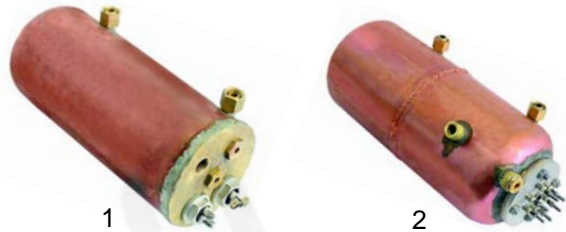

Abb.	Best.-Nr.	Beschreibung	Geräte-Typ	Vergl.-Nr.
1	503100	Boiler kpl.	T34I/ T34S/ Q35S	10157
2	503101	Boiler kpl.	T39I/ T39S/ Q40S	10157B



Abb.	Best.-Nr.	Beschreibung	Geräte-Typ	Vergl.-Nr.
1	503102	Boiler kpl.	Q45F/ Q45FM	10157C
2	503103	Boiler kpl.	Q50F/ Q50FM/ Q50FA/ Q50FAM	10157 I

1	2	3	4	5	6	7	8	9	10						
Pumpe B.-Nr.	Pumpe V.-Nr.	Pumpendeckel B.-Nr.	Pumpendeckel V.-Nr.	Lauftrad B.-Nr.	Lauftrad V.-Nr.	Gleitringdichtg. B.-Nr.	Gleitringdichtg. V.-Nr.	Gegenring B.-Nr.	Gegenring V.-Nr.	Gehäusedicht. B.-Nr.	Gehäusedicht. V.-Nr.	Pumpenkörper B.-Nr.	Pumpenkörper V.-Nr.	Kondensator B.-Nr.	Kondensator V.-Nr.
500334	111130	503126	11166	503128	11169BP	503129	11170	503130	11171	503125	11167	503131	11173	365015	11174
500336	121220	503132	12177	503133	12179	503129	11170	503130	11171	503125	11167	503136	12182	365020	11174B
500335	121230	503132	12177	503134	12179A	503129	11170	503130	11171	503125	11167	503136	12182	365019	11174C